

OCTAGONAL

tapered

This popular shape is available in many strengths up to a 50' overall length lighting pole suitable for arm mounted luminaires. Frequently used in both etched and polished finish in many decor colors, it can also be ordered in the economical light gray standard mold finish.

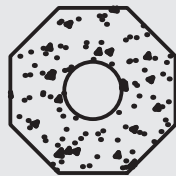

How to Catalog for Octagonal Tapered Pole

Mounting Option

E - Direct Embedment
P - Base Plate

Prestressed

Class A-C

Octagonal
Cross Section

E

300

Height

Overall Pole
Length x 10
5' - 50'

B P O

G

Provision for
Electric Ground

Finish

E - Etched Finish
S - Polished Finish

E

10

Color**

10 - Midnight Lace
11 - Eclipse Black
30 - Salt & Pepper
40 - Pearl Gray
90 - Saluki bronze

Complete with
(To be supplied
by StressCrete)

C/W

140 30/30

Tenon (Post Top Mount)

Specify Tenon Size
For example 140 30/30
= 2 7/8" OD & 3" long

Arms* (Pendant Mount)

100 - Top Mounted Tapered
Elliptical Aluminum Arm
120 - Side Mounted Elliptical
Aluminum Arm
130 - Shoe Box Arm
170 - Victorian Scroll Arm

100

GFI

NA

Options*

DR - 2 Outlets
GFI - Ground Fault 2 Outlet
SR - 1 Outlet
LRN - Ladder Rest
BPC - Base Plate Cover
AB - Anchor Bolts
BA - Banner Arms
FH - Flag Holders

Coating

NA - Non Acrylic
A - Acrylic
AG - Anti Graffiti
Coating***

* Consult website for full listings ** See decor colors on page 2 for full selection of colors
***Anti Graffiti Coating is extra, consult factory for more details.

Octagonal Class A - Light Duty Pole

Octagonal Class A - Light Duty Pole

Physical Details:

- Octagonal symmetrically tapered shaft.
- 5.375" flat to flat pole tip.
- 0.125" per linear ft. taper increase.
- 600 lb. transverse bending strength (2 ft. from tip).
- Mold finish is standard but optional etched or polished finish and Decor colors are available.
- For various luminaire mounting details, please reference arms and accessories.

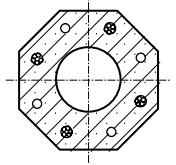

Direct Embedment

Pole Catalog Number	Pole Height Above Grade	Assumed Embedment Depth*	Overall Pole Length	Pole Butt Flat to Flat (Inches)	Ultimate Ground-Line Moment (ft. lbs.**)	Nominal Weight (lbs.)
E-150-APO-G	11' 0"	4' 0"	15' 0"	7.25	5400	495
E-175-APO-G	13' 6"	4' 0"	17' 6"	7.56	6500	600
E-200-APO-G	16' 0"	4' 0"	20' 0"	7.88	8400	710
E-225-APO-G	18' 6"	4' 0"	22' 6"	8.19	9900	825
E-250-APO-G	20' 0"	5' 0"	25' 0"	8.50	10800	975
E-275-APO-G	22' 6"	5' 0"	27' 6"	8.81	12300	1110
E-300-APO-G	25' 0"	5' 0"	30' 0"	9.13	13800	1255
E-325-APO-G	27' 0"	5' 6"	32' 6"	9.44	15000	1400
E-350-APO-G	29' 6"	5' 6"	35' 0"	9.75	16500	1555
E-375-APO-G	32' 0"	5' 6"	37' 6"	10.06	18000	1735
E-400-APO-G	34' 0"	6' 0"	40' 0"	10.38	19200	1990

Base Plate

Pole Catalog Number	Pole Height Above Grade	Pole Butt Flat to Flat (Inches)	Base Plate Size (Inches)	Bolt Circle*** (Inches)	Ultimate Ground-Line Moment (ft. lbs.**)	Nominal Weight (lbs.)
P-150-APO-G	15' 0"	7.25	11.5 x 11.5	11.5	7800	538
P-175-APO-G	17' 6"	7.56	11.5 x 11.5	11.5	9300	640
P-200-APO-G	20' 0"	7.88	11.5 x 11.5	11.5	10800	750
P-225-APO-G	22' 6"	8.19	11.5 x 11.5	11.5	12300	870
P-250-APO-G	25' 0"	8.50	11.5 x 11.5	11.5	13800	1020
P-275-APO-G	27' 6"	8.81	11.5 x 11.5	11.5	15300	1155
P-300-APO-G	30' 0"	9.15	11.5 x 11.5	11.5	16800	1300
P-325-APO-G	32' 6"	9.44	14.5 x 14.5	17	18300	1480
P-350-APO-G	35' 0"	9.75	14.5 x 14.5	17	19800	1635

* Recommended burial depth for normal soils. Where large imbalanced loads are applied or soil strength is questionable, deeper burial may be necessary.

** Ultimate Ground Line Moment = Height above grade minus 2 ft x transverse bending strength.

*** Anchor bolt information - 11.5" BC uses 3/4" x 27" anchor bolts. 17" BC uses 1" x 36" anchor bolts.

Class - EPA Loading

	Pole Height Above Grade	Post Top & Bal. Loads	Imbalanced Loads		
			4' arm	6' arm	8' arm
90 MPH	20	13 3/4	12	10 3/4	9 1/4
	25	11 1/4	9 3/4	9	7 3/4
	30	8 3/4	7 1/2	6 3/4	5 3/4
	35	6	5	4 1/2	3 3/4
100 MPH	20	9 3/4	8 1/2	7 1/2	6 1/4
	25	7 1/4	6 1/2	5 3/4	4 3/4
	30	5	4	3 1/2	2 3/4
	35	2 1/2	1 3/4	1 1/4	1/2
110 MPH	20	7	5 3/4	5	4
	25	4 3/4	3 3/4	3 1/4	2 1/2
	30	2 1/4	1 1/2	1	1/2
	35	---	---	---	---
120 MPH	20	4 3/4	4	3 1/4	2 1/4
	25	2 3/4	1 3/4	1 3/4	3/4
	30	1/4	---	---	---
	35	---	---	---	---
130 MPH	20	3 1/4	2 1/4	1 3/4	1
	25	1 1/4	1/4	---	---
	30	---	---	---	---
	35	---	---	---	---
140 MPH	20	1 3/4	1 1/4	3/4	---
	25	---	---	---	---
	30	---	---	---	---
	35	---	---	---	---
150 MPH	20	3/4	1/4	---	---
	25	---	---	---	---
	30	---	---	---	---
	35	---	---	---	---

Decor Colors & Finishes

Color	Eclipse (Black)	Ash White	Pearl Gray	Dusty Rose	Aztec Jade (Green)	Desert Sand (Buff)	Saluki Bronze (Brown)
Finish							
Etched Finish	E11	E35	E40	E41	E51	E70	E90
Polished	S11	S35	S40	S41	S51	S70	S90

Mold finish, catalog #M00, is standard on all poles. Decor colors and finishes must be specified. A clear acrylic coating is standard on all Decor poles.

◀ When selecting a pole strength class, care must be taken to ensure it will carry the desired EPA loading of arm and luminaire for the wind conditions at your location. If you are unsure of your location's wind condition, please reference Isotach Map in General and Technical section.



Streetlighting Arms and Accessories

Spun concrete poles can be adapted to fit most arms or accessories. Our standards are detailed in the "Arms and Accessories" section of this catalog. If a specific item is not shown, please call your local representative or our sales office.

When requesting StressCrete to supply arms, please ensure compatibility with luminaire.

Finishes

Mold finish is standard on all poles. If a Decor or custom finish is desired it must be specified in the pole catalog number. Please see lower right front page for information, or turn to Decor section.

Standard Openings and Handholes

(For more detailed information, please reference General and Technical section.)

- 2 1/2" x 8" is the standard handhole box located 18" above grade. Both it and the tight fitting coverplate are available in non-metallic, non-conductive injection molded material or a rugged high density cast zinc.
- Standard coverplate fasteners are 1/4" stainless steel with either Allen (hex) head for the United States or black Robertson #3 (square) head in Canada. Tamperproof and non-standard fasteners are available but must be specified.
- Standard above grade wiring apertures vary with arm selection but are generally 1 1/4" diameter holes or 1 1/2" x 3" openings. Below grade apertures are 2 1/2" x 5" double openings 18" below grade in line with handhole.
- Non-standard sizes can be made available on request; please contact our sales office.
- Galvanized steel or zinc inserts are available in 1/8" increments from 1/4" through 3/4".
- Through holes are nominal 1/2", 3/4", or 1".

Electrical Grounding

The last letter of our pole catalog number "G" specifies that the pole will be supplied complete with a #6 stranded copper ground wire. When properly connected, this will electrically ground the pole. If the pole is not to be electrically grounded, simply delete the letter "G" from the catalog number.

Footings

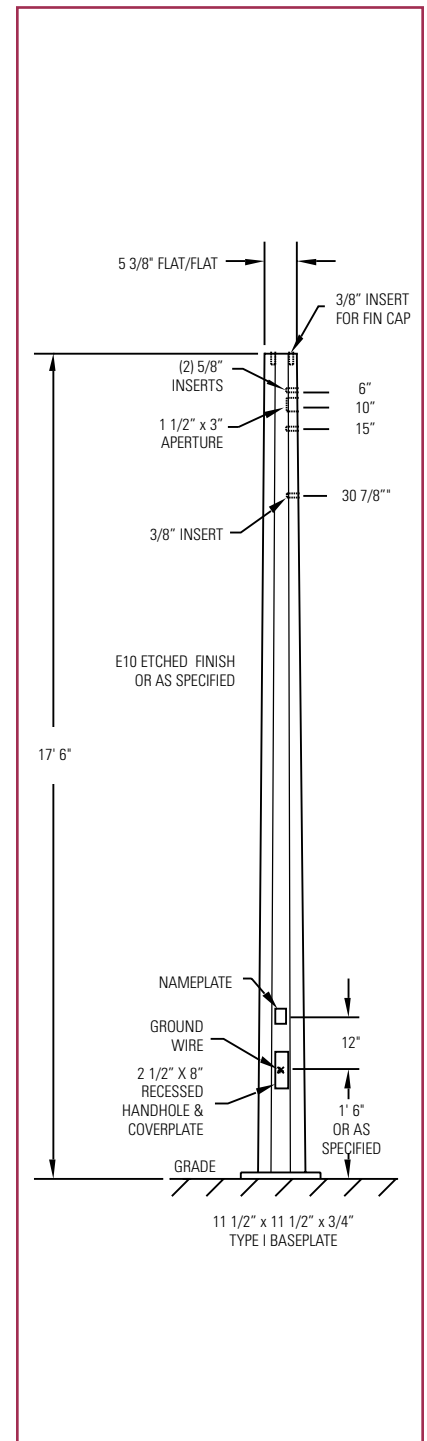
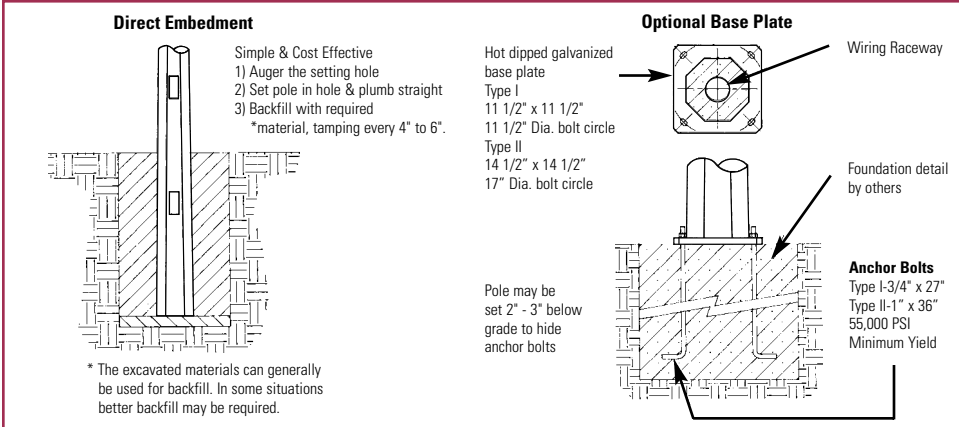

Typical Catalog Numbers

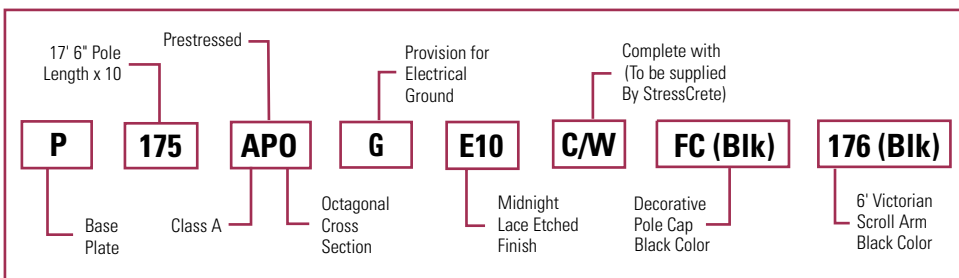

Typical for all types:

1. Select footing type - direct embedment or base plate.
2. Select pole length - if direct embedded allow for embedment length.
3. Select shape and strength of pole.
4. If required, select provision for electrical grounding of pole.
5. If desired, select Decor color and finish.
6. Select luminaire mounting style - see arms and accessories.



Octagonal Class B - Medium Duty Pole

Octagonal Class B - Medium Duty Pole

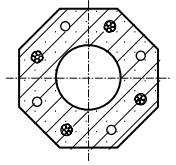

Physical Details:

- Octagonal symmetrically tapered shaft.
- 5.375" flat to flat pole tip.
- 0.125" per linear ft. taper increase.
- 900 lb. transverse bending strength (2 ft. from tip).
- Mold finish is standard but optional etched or polished finish and Decor colors are available.
- For various luminaire mounting details, please reference arms and accessories.

Direct Embedment

Pole Catalog Number	Pole Height Above Grade	Assumed Embedment Depth*	Overall Pole Length	Pole Butt Flat to Flat (Inches)	Ultimate Ground-Line Moment (ft. lbs.**)	Nominal Weight (lbs.)
E-250-BPO-G	20' 0"	5' 0"	25' 0"	8.50	16200	1010
E-275-BPO-G	22' 6"	5' 0"	27' 6"	8.81	18450	1150
E-300-BPO-G	25' 0"	5' 0"	30' 0"	9.13	20700	1300
E-325-BPO-G	27' 0"	5' 6"	32' 6"	9.44	22500	1450
E-350-BPO-G	29' 6"	5' 6"	35' 0"	9.75	24750	1610
E-375-BPO-G	32' 0"	5' 6"	37' 6"	10.06	27000	1780
E-400-BPO-G	34' 0"	6' 0"	40' 0"	10.38	28800	2035
E-425-BPO-G	36' 6"	6' 0"	42' 6"	10.69	31050	2235
E-450-BPO-G	39' 6"	6' 0"	45' 0"	11.00	33300	2455

Base Plate

Pole Catalog Number	Pole Height Above Grade	Pole Butt Flat to Flat (Inches)	Base Plate Size (Inches)	Bolt Circle*** (Inches)	Ultimate Ground-Line Moment (ft. lbs.**)	Nominal Weight (lbs.)
P-250-BPO-G	25' 0"	8.50	11.5 x 11.5	11.5	20700	1090
P-275-BPO-G	27' 0"	8.81	11.5 x 11.5	11.5	22950	1230
P-300-BPO-G	30' 0"	9.13	11.5 x 11.5	11.5	25200	1375
P-325-BPO-G	32' 6"	9.44	14.5 x 14.5	17	27450	1530
P-350-BPO-G	35' 0"	9.75	14.5 x 14.5	17	29700	1690
P-375-BPO-G	37' 6"	10.06	14.5 x 14.5	17	31950	1860
P-400-BPO-G	40' 0"	10.38	14.5 x 14.5	17	34200	2125

* Recommended burial depth for normal soils. Where large imbalanced loads are applied or soil strength is questionable, deeper burial may be necessary.

** Ultimate Ground Line Moment = Height above grade minus 2 ft x transverse bending strength.

*** Anchor bolt information - 11.5" BC uses 3/4" x 27" anchor bolts. 17" BC uses 1" x 36" anchor bolts.

Class - EPA Loading

	Pole Height Above Grade	Post Top & Bal. Loads	Imbalanced Loads		
			4' arm	6' arm	8' arm
90 mph	20	23 3/4	22	20 3/4	19 1/4
	25	21	19 3/4	18 3/4	17 1/2
	30	18 1/4	17 1/4	16 1/2	15 1/2
	35	15 1/2	14 1/2	13 3/4	13
	40	12 1/2	11 3/4	11 1/4	10 1/2
100 mph	20	18	16 3/4	15 3/4	14 1/4
	25	15 1/2	14 1/4	13 1/2	12 1/2
	30	12 3/4	12	11 1/4	10 1/2
	35	10	9 1/4	8 3/4	8 1/4
	40	7 1/4	6 1/2	6 1/4	5 3/4
110 mph	20	13 3/4	12 1/2	11 3/4	10 3/4
	25	11 1/4	10 1/2	9 3/4	9
	30	8 3/4	8	7 1/2	6 3/4
	35	6 1/4	5 1/2	5	4 1/2
	40	3 1/2	3	2 1/2	2
120 mph	20	10 1/2	9 1/2	9	8
	25	8 1/4	7 1/2	6 3/4	6 1/4
	30	5 3/4	5	4 3/4	4
	35	3 1/4	2 1/2	2 1/4	1 3/4
	40	1/2	---	---	---
130 mph	20	8	7 1/4	6 1/2	5 3/4
	25	5 3/4	5	4 1/2	4
	30	3 1/4	2 3/4	2 1/2	2
	35	3/4	1/4	---	---
	40	---	---	---	---
140 mph	20	6	5 1/4	3/4	4 1/4
	25	3 3/4	3 1/4	2 3/4	2 1/4
	30	1 1/2	1	1/2	1/4
	35	---	---	---	---
	40	---	---	---	---
150 mph	20	4 1/2	3 3/4	3 1/4	2 3/4
	25	2 1/4	1 3/4	1 1/4	1
	30	---	---	---	---
	35	---	---	---	---
	40	---	---	---	---

Decor Colors & Finishes

Color / Finish	Eclipse (Black)	Ash White	Pearl Gray	Dusty Rose	Aztec Jade (Green)	Desert Sand (Buff)	Saluki Bronze (Brown)
Etched Finish	E11	E35	E40	E41	E51	E70	E90
Polished Finish	S11	S35	S40	S41	S51	S70	S90

Mold finish, catalog #M00, is standard on all poles. Decor colors and finishes must be specified. A clear acrylic coating is standard on all Decor poles.

◀ When selecting a pole strength class, care must be taken to ensure it will carry the desired EPA loading of arm and luminaire for the wind conditions at your location. If you are unsure of your location's wind condition, please reference Isotach Map in General and Technical section.



Streetlighting Arms and Accessories

Spun concrete poles can be adapted to fit most arms or accessories. Our standards are detailed in the "Arms and Accessories" section of this catalog. If a specific item is not shown, please call your local representative or our sales office.

When requesting StressCrete to supply arms, please ensure compatibility with luminaire.

Finishes

Mold finish is standard on all poles. If a Decor or custom finish is desired it must be specified in the pole catalog number. Please see lower right front page for information, or turn to Decor section.

Standard Openings and Handholes

(For more detailed information, please reference General and Technical section.)

- 2 1/2" x 8" is the standard handhole box located 18" above grade. Both it and the tight fitting coverplate are available in non-metallic, non-conductive injection molded material or a rugged high density cast zinc.
- Standard coverplate fasteners are 1/4" stainless steel with either Allen (hex) head for the United States or black Robertson #3 (square) head in Canada. Tamperproof and non-standard fasteners are available but must be specified.
- Standard above grade wiring apertures vary with arm selection but are generally 1 1/4" diameter holes or 1 1/2" x 3" openings. Below grade apertures are 2 1/2" x 5" double openings 18" below grade in line with handhole.
- Non-standard sizes can be made available on request; please contact our sales office.
- Galvanized steel or zinc inserts are available in 1/8" increments from 1/4" through 3/4".
- Through holes are nominal 1/2", 3/4", or 1".

Electrical Grounding

The last letter of our pole catalog number "G" specifies that the pole will be supplied complete with a #6 stranded copper ground wire. When properly connected, this will electrically ground the pole. If the pole is not to be electrically grounded, simply delete the letter "G" from the catalog number.

Footings

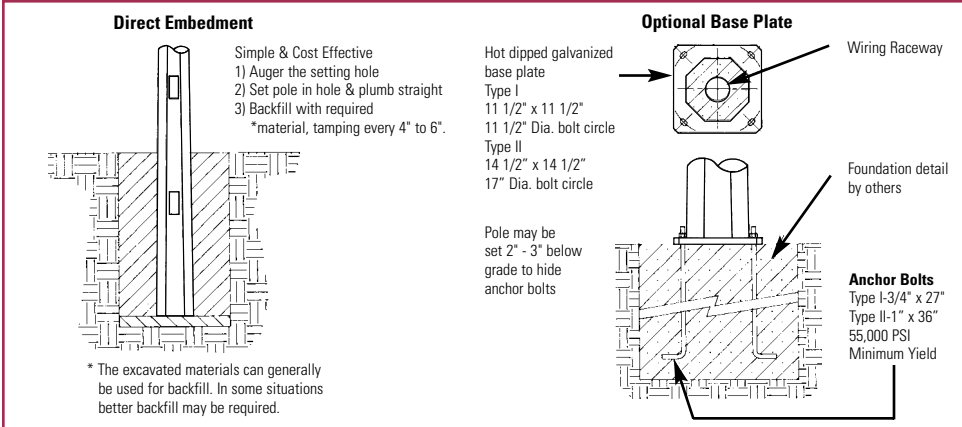

Typical Catalog Numbers

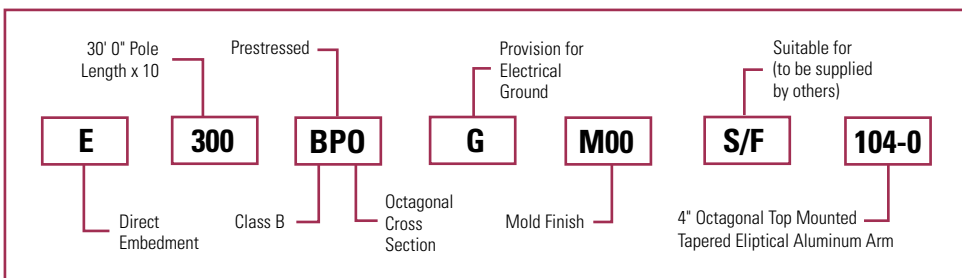

Typical for all types:

1. Select footing type - direct embedment or base plate.
2. Select pole length - if direct embedded allow for embedment length.
3. Select shape and strength of pole.
4. If required, select provision for electrical grounding of pole.
5. If desired, select Decor color and finish.
6. Select luminaire mounting style - see arms and accessories.

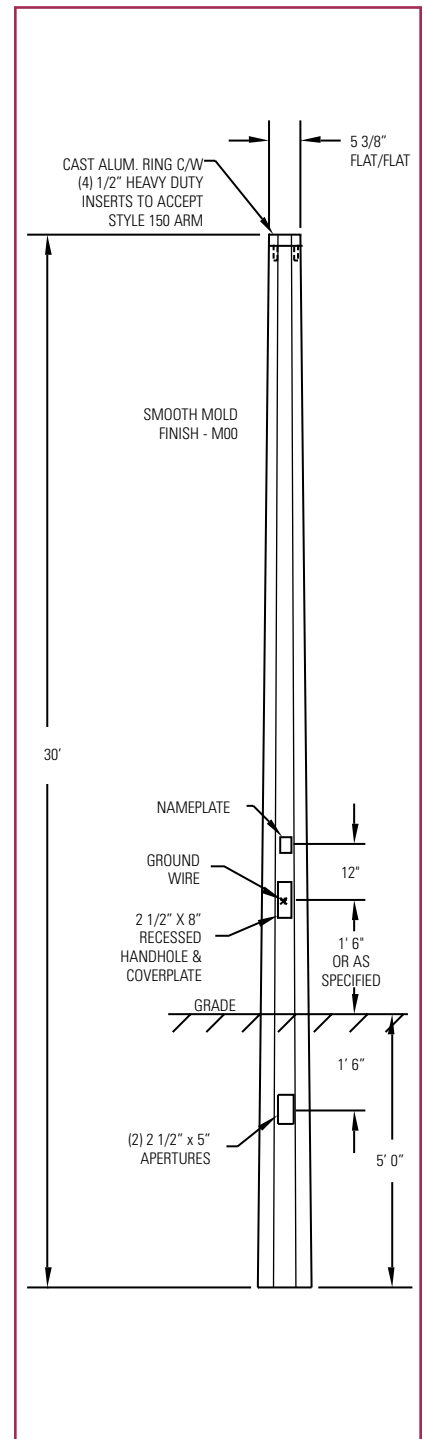

StressCrete

Octagonal Class C - Heavy Duty Pole

Octagonal, Class C - Heavy Duty Pole

Physical Details:

- Octagonal symmetrically tapered shaft.
- 6.0" flat to flat pole tip.
- 0.125" per linear ft. taper increase.
- 1200 lb. transverse bending strength (2 ft. from tip).
- Mold finish is standard but optional etched or polished finish and Decor colors are available.
- For various luminaire mounting details, please reference arms and accessories.

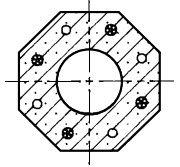

Direct Embedment

Pole Catalog Number	Pole Height Above Grade	Assumed Embedment Depth*	Overall Pole Length	Pole Butt Flat to Flat (Inches)	Ultimate Ground-Line Moment (ft. lbs.**)	Nominal Weight (lbs.)
E-300-CPO-G	25' 0"	5' 0"	30' 0"	9.75	27600	1475
E-325-CPO-G	27' 0"	5' 6"	32' 6"	10.06	30000	1640
E-350-CPO-G	29' 6"	5' 6"	35' 0"	10.38	33000	1835
E-375-CPO-G	32' 0"	5' 6"	37' 6"	10.69	36000	2020
E-400-CPO-G	34' 0"	6' 0"	40' 0"	11.00	38400	2300
E-425-CPO-G	36' 6"	6' 0"	42' 6"	11.31	41400	2535
E-450-CPO-G	39' 0"	6' 0"	45' 0"	11.63	44400	2770

Base Plate

Pole Catalog Number	Pole Height Above Grade	Pole Butt Flat to Flat (Inches)	Base Plate Size (Inches)	Bolt Circle*** (Inches)	Ultimate Ground-Line Moment (ft. lbs.**)	Nominal Weight (lbs.)
P-300-CPO-G	30' 0"	9.75	14.5 x 14.5	17	33600	1555
P-325-CPO-G	32' 6"	10.06	14.5 x 14.5	17	36600	1735
P-350-CPO-G	35' 0"	10.38	14.5 x 14.5	17	39600	1925
P-375-CPO-G	37' 6"	10.69	14.5 x 14.5	17	42600	2110
P-400-CPO-G	40' 0"	11.00	14.5 x 14.5	17	45600	2395
P-425-CPO-G	42' 6"	11.31	14.5 x 14.5	17	48600	2630
P-450-CPO-G	45' 0"	11.63	14.5 x 14.5	17	51600	2870

* Recommended burial depth for normal soils. Where large imbalanced loads are applied or soil strength is questionable, deeper burial may be necessary.

** Ultimate Ground Line Moment = Height above grade minus 2 ft x transverse bending strength.

*** Anchor bolt information - 17" BC uses 1" x 36" anchor bolts.

Class - EPA Loading

	Pole Height Above Grade	Post Top & Bal. Loads	Imbalanced Loads			
			8' arm	10 arm	12' arm	15 arm
90 mph	30	26 3/4	23 3/4	22 1/2	21 1/4	18 1/2
	35	23 3/4	21 1/4	20 1/4	19	17
	40	20 3/4	18 3/4	17 3/4	16 3/4	15
	45	17 3/4	16	15 1/4	14 1/4	12 3/4
100 mph	30	19 1/2	17	16	15	12 3/4
	35	16 1/2	14 1/2	13 3/4	12 3/4	11
	40	13 3/4	12	11 1/2	10 1/2	9
	45	11	9 1/2	8 3/4	8 1/4	7
110 mph	30	14 1/2	12	11 1/4	10 1/4	8 1/2
	35	11 1/4	9 3/4	9	8 1/4	6 3/4
	40	8 1/2	7 1/4	6 3/4	6	4 3/4
	45	6	4 3/4	4 1/4	3 1/2	2 1/2
120 mph	30	10	8 1/4	7 1/2	6 3/4	5 1/4
	35	7 1/4	6	5 1/4	4 3/4	3 1/2
	40	4 3/4	3 1/2	3	2 1/2	1 1/2
	45	2	1	1/2	—	—
130 mph	30	6 3/4	5 1/4	4 3/4	4	2 3/4
	35	4 1/4	3	2 1/2	2	1
	40	1 1/2	1/2	1/4	—	—
	45	—	—	—	—	—
140 mph	30	4 1/4	3	2 1/2	1 3/4	3/4
	35	1 3/4	3/4	1/4	—	—
	40	—	—	—	—	—
	45	—	—	—	—	—
150 mph	30	2	1	3/4	—	—
	35	—	—	—	—	—
	40	—	—	—	—	—
	45	—	—	—	—	—

Decor Colors & Finishes

Color / Finish	Eclipse (Black)	Ash White	Pearl Gray	Dusty Rose	Aztec Jade (Green)	Desert Sand (Buff)	Saluki Bronze (Brown)
Etched Finish	E11	E35	E40	E41	E51	E70	E90
Polished Finish	S11	S35	S40	S41	S51	S70	S90

Mold finish, catalog #M00, is standard on all poles. Decor colors and finishes must be specified. A clear acrylic coating is standard on all Decor poles.

◀ When selecting a pole strength class, care must be taken to ensure it will carry the desired EPA loading of arm and luminaire for the wind conditions at your location. If you are unsure of your location's wind condition, please reference Isotach Map in General and Technical section.



Streetlighting Arms and Accessories

Spun concrete poles can be adapted to fit most arms or accessories. Our standards are detailed in the "Arms and Accessories" section of this catalog. If a specific item is not shown, please call your local representative or our sales office.

When requesting StressCrete to supply arms, please ensure compatibility with luminaire.

Finishes

Mold finish is standard on all poles. If a Decor or custom finish is desired it must be specified in the pole catalog number. Please see lower right front page for information, or turn to Decor section.

Standard Openings and Handholes

(For more detailed information, please reference General and Technical section.)

- 2 1/2" x 8" is the standard handhole box located 18" above grade. Both it and the tight fitting coverplate are available in non-metallic, non-conductive injection molded material or a rugged high density cast zinc.
- Standard coverplate fasteners are 1/4" stainless steel with either Allen (hex) head for the United States or black Robertson #3 (square) head in Canada. Tamperproof and non-standard fasteners are available but must be specified.
- Standard above grade wiring apertures vary with arm selection but are generally 1 1/4" diameter holes or 1 1/2" x 3" openings. Below grade apertures are 2 1/2" x 5" double openings 18" below grade in line with handhole.
- Non-standard sizes can be made available on request; please contact our sales office.
- Galvanized steel or zinc inserts are available in 1/8" increments from 1/4" through 3/4".
- Through holes are nominal 1/2", 3/4", or 1".

Electrical Grounding

The last letter of our pole catalog number "G" specifies that the pole will be supplied complete with a #6 stranded copper ground wire. When properly connected, this will electrically ground the pole. If the pole is not to be electrically grounded, simply delete the letter "G" from the catalog number.

Footings

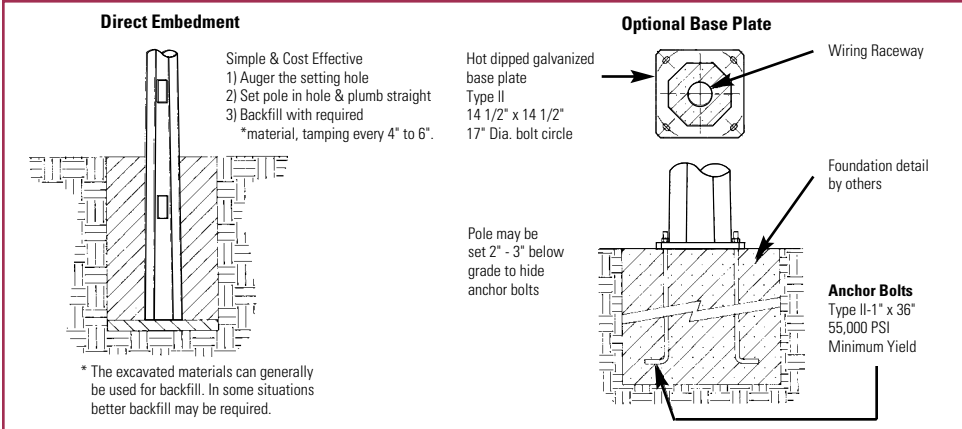

Typical Catalog Numbers

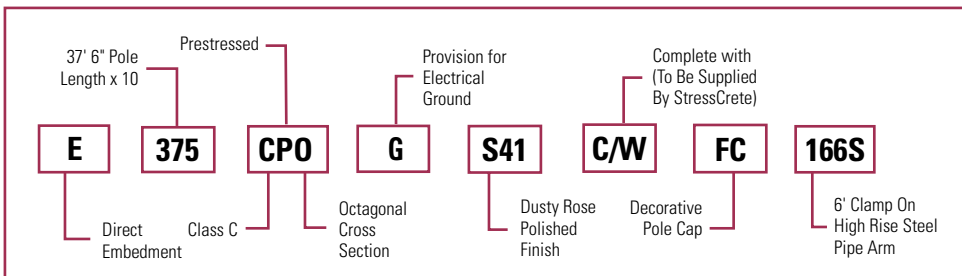

Typical for all types:

1. Select footing type - direct embedment or base plate.
2. Select pole length - if direct embedded allow for embedment length.
3. Select shape and strength of pole.
4. If required, select provision for electrical grounding of pole.
5. If desired, select Decor color and finish.
6. Select luminaire mounting style - see arms and accessories.

